



US00D742373S

(12) **United States Design Patent**
Ji et al.

(10) **Patent No.:** **US D742,373 S**

(45) **Date of Patent:** **** Nov. 3, 2015**

(54) **MOBILE PHONE**

(71) Applicant: **LG Electronics Inc.**, Seoul (KR)

(72) Inventors: **Seunghyun Ji**, Seoul (KR); **Hyunwoo Yoo**, Seoul (KR)

(73) Assignee: **LG Electronics Inc.**, Seoul (KR)

(**) Term: **14 Years**

(21) Appl. No.: **29/497,057**

(22) Filed: **Jul. 21, 2014**

(30) **Foreign Application Priority Data**

Jan. 22, 2014 (KR) 30-2014-0003507

(51) **LOC (10) Cl.** **14-02**

(52) **U.S. Cl.**
USPC **D14/344**; D14/138 R; D14/144;
D10/38

(58) **Field of Classification Search**

USPC D14/140, 137, 138 R, 138 AB, 139, 144,
D14/155, 167, 191, 192, 203.1, 203.3,
D14/203.4, 203.5, 203.7, 248, 226, 218,
D14/240, 344, 440, 341, 346, 448, 450,
D14/496; D10/30-32, 37-39, 65, 70, 77,
D10/78, 98, 104.1, 104.2, 125; D11/3-5,
D11/12, 19, 25; D13/168; D3/215;
D15/199; 381/364, 151; 379/433.1;
455/575.1, 575.3, 575.4, 575.6, 556.1,
455/556.2, 558, 90.3; 368/10, 13, 69, 223,
368/281, 282, 294, 295, 296; D21/329,
D21/513; D24/167, 186
CPC H04B 1/03; H04B 1/385; G04G 9/00;
G04G 17/00; G04G 17/04; G04G 17/06;
G04G 17/083; H04M 1/0227; H04M 1/03;
H04M 1/04

See application file for complete search history.

(56) **References Cited**

U.S. PATENT DOCUMENTS

D103,455	S	*	3/1937	Katz	D10/38
D236,592	S	*	9/1975	Partmann	D10/32
D238,758	S	*	2/1976	Schulthess	D10/38
D260,411	S	*	8/1981	Rubin	D21/513
4,419,770	A	*	12/1983	Yagi et al.	455/301
D279,671	S	*	7/1985	Stanton	D14/192
D296,675	S	*	7/1988	Jones et al.	D10/31
D297,312	S	*	8/1988	Ishizaka	D10/32
D299,028	S	*	12/1988	Hermann	D14/344

(Continued)

OTHER PUBLICATIONS

12 Star Trek gadgets that became reality. slipperybrick.com (online) 1 pg. Uploaded: Jan. 29, 2008 [retrieved on Jun. 22, 2015]. Retrieved from Internet: <<http://www.slipperybrick.com/2008/01/star-trek-gadgets/>>.*

Primary Examiner — Susan Bennett Hattan

Assistant Examiner — Marie Fast Horse

(74) *Attorney, Agent, or Firm* — Morgan, Lewis & Bockius LLP

(57) **CLAIM**

The ornamental design for a mobile phone, as shown and described.

DESCRIPTION

FIG. 1 is a perspective view of a mobile phone showing our new design;

FIG. 2 is a front view thereof;

FIG. 3 is a rear view thereof;

FIG. 4 is a left side view thereof;

FIG. 5 is a right side view thereof;

FIG. 6 is a top plan view thereof; and,

FIG. 7 is a bottom plan view thereof.

The broken lines depicts parts of the mobile phone that form no part of the claimed design.

1 Claim, 6 Drawing Sheets

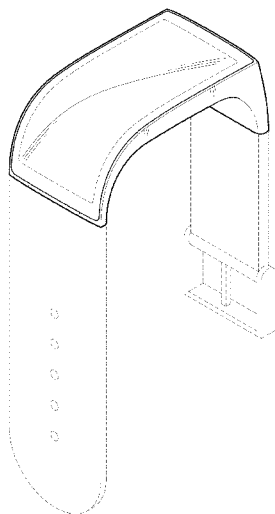

(56)

References Cited

U.S. PATENT DOCUMENTS

5,218,577	A *	6/1993	Seager	368/10	D636,686	S *	4/2011	Cobbett et al.	D10/38
5,235,560	A *	8/1993	Seager	368/10	D709,476	S *	7/2014	Park et al.	D14/138 R
5,381,387	A *	1/1995	Blonder et al.	368/10	D720,074	S *	12/2014	Suvilaakso et al.	D24/167
D398,246	S *	9/1998	Bruce et al.	D10/30	D725,068	S *	3/2015	Cho et al.	D14/138 R
D449,008	S *	10/2001	Sargent	D10/32	D725,072	S *	3/2015	Kim et al.	D14/138 R
6,564,075	B1 *	5/2003	Mitamura	455/575.1	D726,140	S *	4/2015	Park et al.	D14/138 R
D488,391	S *	4/2004	Kume	D10/32	D727,195	S *	4/2015	Wanliss-Orlebar et al.	D11/3
D496,590	S *	9/2004	Chung et al.	D10/31	D730,348	S *	5/2015	Grifoni	D14/344
D543,192	S *	5/2007	Jung	D14/138 R	2002/0103014	A1 *	8/2002	Hutchison et al.	455/575
D568,768	S *	5/2008	Tang	D10/30	2006/0203621	A1 *	9/2006	Brodmann	368/281
D589,375	S *	3/2009	Tang	D10/32	2009/0201767	A1 *	8/2009	Caldwell	368/10
7,828,697	B1 *	11/2010	Oberrieder et al.	482/8	2013/0211204	A1 *	8/2013	Caduff et al.	600/300
					2013/0261405	A1 *	10/2013	Lee et al.	600/301
					2015/0099472	A1 *	4/2015	Ickovic	455/66.1

* cited by examiner

FIG. 1

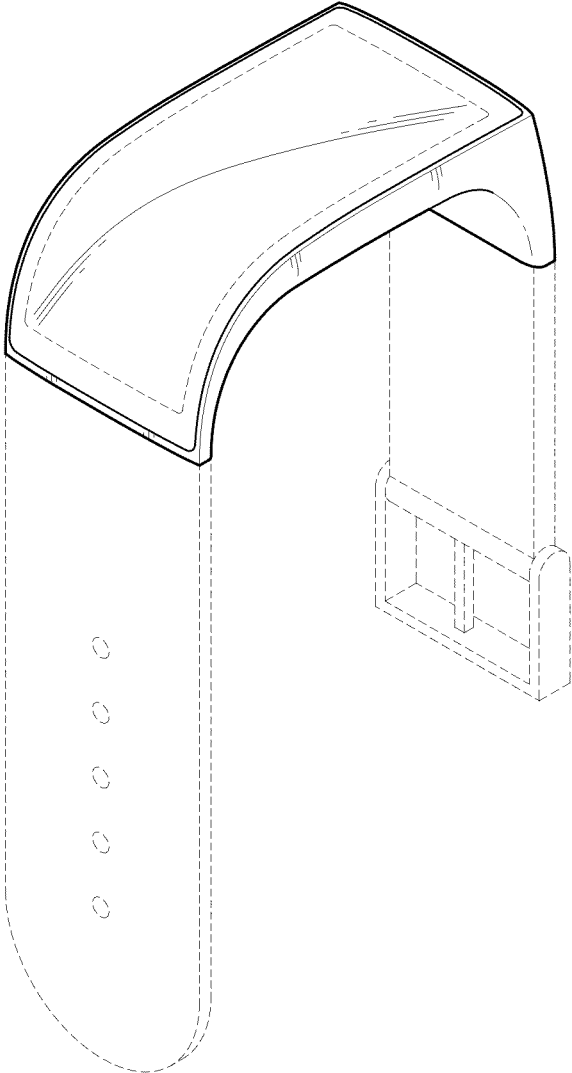

FIG. 2

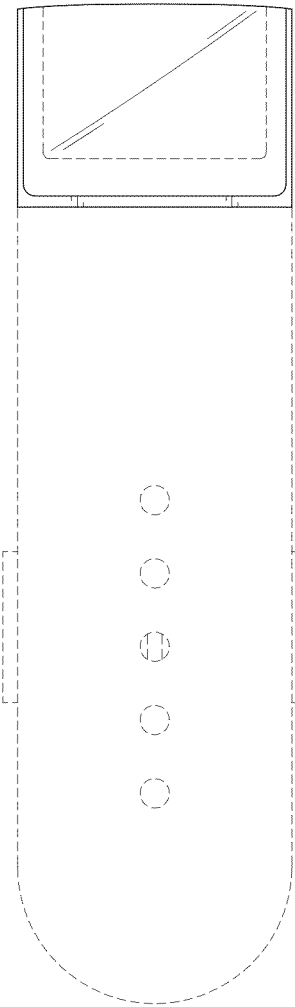

FIG. 3

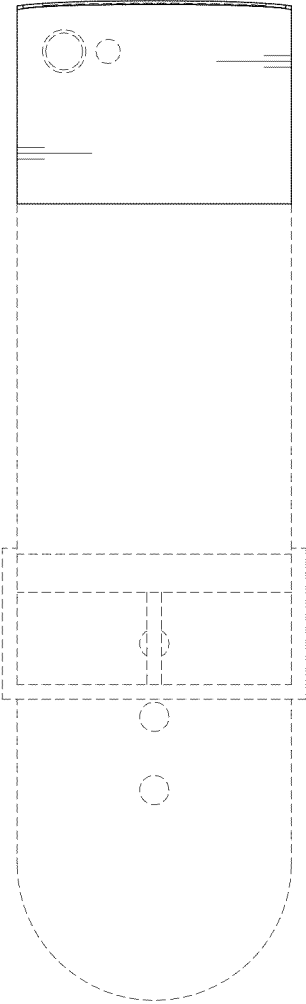

FIG. 4

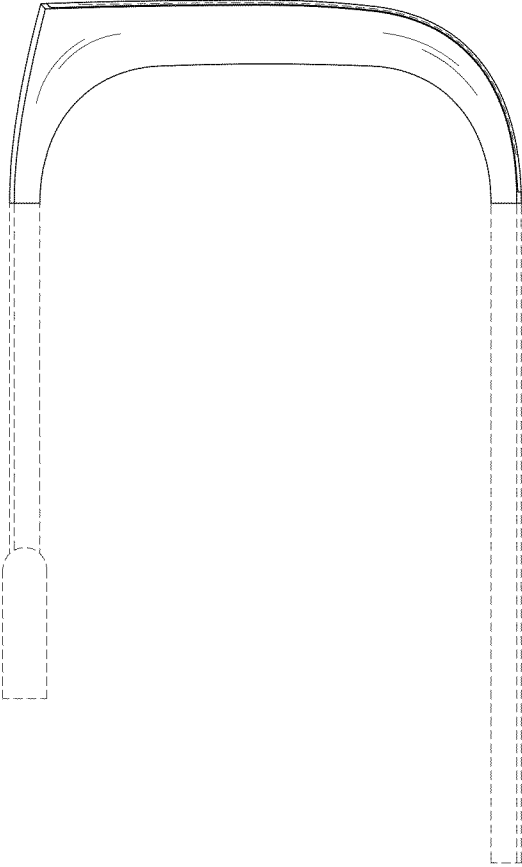

FIG. 5

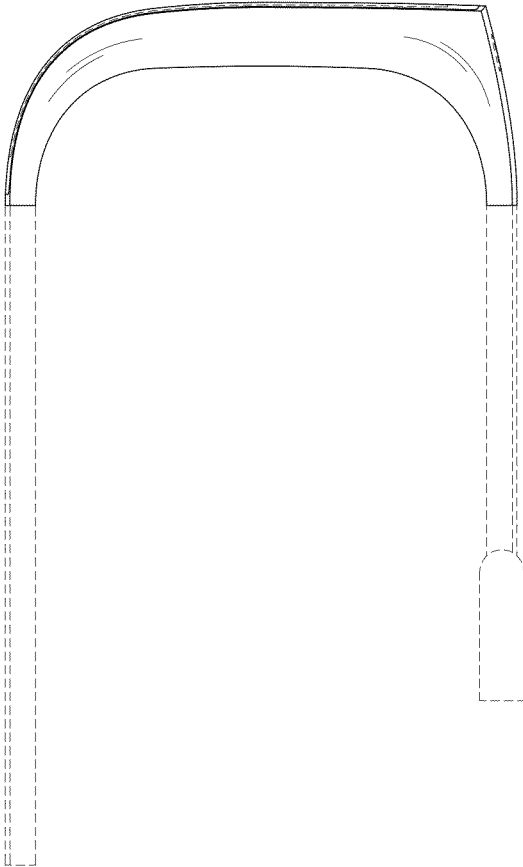

FIG. 6

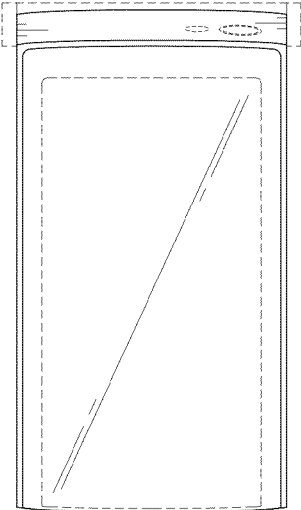

FIG. 7

